



Synco™ living

## **HVAC central apartment unit with consumption data acquisition**

### **QAX903**

Series A

- 
- Heating and cooling control management for an apartment including pre-control for 2 room groups
  - Ventilation plant management
  - Air conditioning equipment management (e.g. split units)
  - Selection of operating mode, timer and holidays/special day function for the apartment
  - Independent time switches and operating modes for 12 rooms
  - Absence function (heating, cooling, ventilation)
  - Summer operation with preselected valve position for cooling mode
  - Display of meteorological data
  - Radio communication with devices from the Synco living radio range
  - Universal input and output
  - Remote control using a web server
  - Acquisition of consumption data for heating, water, electricity, and gas
  - KNX-based wireless (868 MHz, bidirectional) and wired data transmission
  - Mains-powered AC 230 V operation

- Heating and cooling control management for an apartment.
- Radiator/floor cooling monitored for dew point.
- Increase the Economy room setpoint and minimum flow temperature setpoint dependent on composite outside air temperature.
- Collect heating/refrigeration requests from individual rooms.
- Generate heating or refrigeration request signals and transmit them to heating and refrigeration generation via wired bus, via heat/refrigeration demand relay, or via DC 0...10 V output to the RRV912 or RRV934.
- Suited for heating and cooling plants with central distribution (e.g. floor heating) and radiators with decentralized connections.
- Limit the heating setpoint (max.) and cooling setpoint (min.).
- Control heating circuits with RRV912/RRV918 heating controllers and SSA955 radiator control actuators.
- Control the flow temperature of 2 independent room groups with limitation function (min/max) and maintain return temperature high/low.
- Control the room groups' pumps via universal relay outputs.
- Manage a ventilation plant via multi-controller RRV934.
- Night cooling function (heat recovery bypass function).
- Air conditioning unit control (split units) via universal outputs (local and RRV91x) or via S-mode (KNX TP1).
- Release cooling enable contacts for each room dependent on the composite outside temperature, present HVAC level, window status, and heating demand.
- Display outside temperature curve and outside air pressure over the last 24 hours using the QAC910 meteo sensor.
- Indicate open windows.
- Display weather trends (sunny, varying, bad).
- Record consumption data for heat, water, electricity, and gas using the consumption data interface WRI982.
- Remote access via Siemens OZW77x central communication units.
- Remote control of the Synco living system via web portal.

**Equipment combinations**

The unit can be used together with the following wireless products of the Siemens Synco living system and those of other suppliers of KNX RF products:

Device designation	Type	Documentation
Room unit	QAW910	N2703en
Room temperature sensor	QAA910	N270en
Meteo sensor	QAC910	N2702en
Heating circuit controller	RRV912	N2705en
Heating circuit controller	RRV918	N2706en
Multi-controller	RRV934	N2709en
Radiator control actuator	SSA955	N2700en
Radio repeater	ERF910	N2704en
Consumption data interface	WRI982	N2735en
Web server	OZW772.xx	N5701en
Door and window contacts	GAMMA wave	Siemens

The QAX903 central apartment unit can be used together with the following hard-wired products from the Siemens Synco 700 system:

Device designation	Type	Documentation
Synco 700 control units	RM..	S3110en
Central communication units	OZW771 OZW775	N3117en N5663en
Service tool	OCI700.1	N5655en

See also the product range overview "Acvatix valves and actuators 0-92205-en".

Additional KNX TP1 units can be integrated via S-mode (refer to document CE1Y3110en).

Device designation	Type	Documentation
Interface for cooling units (split units)	IRSC	ZENNiO

## Ordering

Please specify the quantity, product name, and type when ordering.

### Scope of delivery

The central apartment unit is available in two models:

- QAX903-xx: With mounting and commissioning instructions, a user's guide and the required installation materials  
→ (Example with French instructions/guides: QAX903-FR).
- QAX903-9: Featuring multi-lingual mounting instructions and the necessary installation materials. The following languages can be set on the QAX903-9: Bulgarian, Danish, German, English, Finnish, French, Greek, Italian, Croatian, Dutch, Norwegian, Polish, Portuguese, Romanian, Russian, Swedish, Serbian, Slovakian, Slovenian, Spanish, Czech, Turkish, and Hungarian.  
The instructions/guides can be downloaded from the Internet in the various languages at [www.siemens.com/syncoliving-td](http://www.siemens.com/syncoliving-td).

### Order numbers

Type	Stock number	Designation
QAX903-DE	S55621-H110	Central apartment unit with accompanying documentation in German.
QAX903-FR	S55621-H113	Central apartment unit with accompanying documentation in French.
QAX903-IT	S55621-H115	Central apartment unit with accompanying documentation in Italian.
QAX903-NL	S55621-H119	Central apartment unit with accompanying documentation in Dutch
QAX903-PL	S55621-H121	Central apartment unit with accompanying documentation in Polish
QAX903-CS	S55621-H123	Central apartment unit with accompanying documentation in Czech
QAX903-9	S55621-H125	Central apartment unit with mounting instructions

## Functions

---

### Primary functions

The central apartment unit manages heating, cooling and ventilation control of an apartment with up to 12 rooms.

In addition, it allows for controlling air conditioning units (split units).

You can record consumption, together with the consumption data interface WRI982, for heating/refrigeration, hot and chilled water, electricity and natural gas, display it on the QAX903 central apartment unit, and forward it via the OZW772 web server to a service provider.

The central apartment unit also serves as an operator and display unit for the apartment.

### Specific functions for heating and cooling plants

#### Heating/cooling request

The central apartment unit forms a heating or cooling demand signal from the collected heating or cooling requests and forwards it to the heating or refrigeration generation controller.

The heating/refrigeration demand signal can be delivered via the universal relay output (switching) or at the DC 0...10 V output (modulating) of an RRV912 heating circuit controller or RRV934 multi-controller.

#### Flow temperature control/limitation

The flow temperature can be controlled via the RRV934 multi-controller. It is regulated with the help of the heating/refrigeration demand signal. Based on an adjustable value, minimum as well as maximum limitation of the flow temperature is possible. If the temperature request is invalid, flow temperature control becomes inactive and the actuating elements are closed during winter operation (no output). The central apartment unit supports two room groups (e.g. floor heating/cooling and radiators) that may be controlled independently.

#### Return temperature limitation

The return temperature can be maintained at an adjustable high or low level. This prevents, for example, water that is too hot from returning to generation. Return temperature limitation takes priority over flow temperature limitation. Return temperature limitation acts on the mixing valve for the room group.

#### Setpoint limitation

Setpoint limitation limits the heating setpoint to a maximum value and the cooling setpoint to a minimum value for the entire apartment.

#### Room unit/ Room temperature sensor

The central apartment unit calculates the mean value and uses it for room temperature control if a room unit and one or two room sensors are assigned to a room.

#### Parallel operation of heating circuit controllers

Several heating circuits connected to an RRV912 / RRV918 heating circuit controller can be combined to form one room and operated in parallel. In that case, the first channel ensures actual room control while, at the same time, controlling the other assigned channels.

#### Parallel operation of radiator control actuators

Up to 6 SSA955 radiator control actuators can be combined to form one room and operated in parallel.

In that case, the radiator control actuator connected first (lead controller) assumes actual room control plus wireless control of the other assigned radiator control actuators (lag controllers).

<b>Zone control</b>	Multiple heating circuits connected to common heat distributor can be controlled jointly as a zone. The zone valve (3-point) is controlled based on the temperature measured value from the room unit and/or room temperature sensor installed in the reference room.
<b>Room group pumps</b>	The central apartment unit enables the room group pumps. They can be either connected to the internal relay output or a relay output of one of the RRV912 / RRV918 heating circuit controllers or RRV934 multi-controller.
<b>Antilime function</b>	<p>The QAX903 can trigger an antilime function at regular intervals to prevent valve plugs and pump impellers from seizing during longer off periods. The function ensures the valve actuators extend to the fully open and fully closed position and the pumps are activated for short periods of time (valve kick). Frequency and time of day the function is performed can be adjusted.</p> <p>The antilime function acts either locally or on components connected to the RRV912 / RRV918 heating circuit controller as well as on wireless SSA955 radiator control actuators.</p>
<b>Outside air temperature-controlled night setback</b>	The Economy room temperature setpoint to heat all rooms is increased dependent on the composite outside temperature. The transitions are adjustable and help prevent peak loads during changeover, for example, from Economy to Precomfort or Comfort.
<b>Minimum flow setpoint</b>	The minimum flow temperature setpoint is increased depending on the composite outside air temperature, ensuring a minimum flow temperature in uncontrolled rooms.
<b>Summer operation</b>	<p>The central apartment unit triggers summer operation. Changeover can occur manually, by date, as per attenuated outside air temperature, via a digital input, or through active changeover to cooling mode.</p> <p>The heating circuit valves connected to an RRV912 / RRV918 heating circuit controller have a position of 0% or 100% and the SSA955 radiator control actuators are driven to the preselected valve positions.</p>
<b>Specific functions for floor cooling</b>	
<b>Room control</b>	<p>4 cooling setpoints can be preset for each room. A flow refrigeration request is calculated per room group for primary processing. The room group controller RRV934 controls the flow temperature depending on composite outside air temperature and individually adjustable cooling curve.</p> <p>QAX903 can override room controllers RRV912, RRV918 and SSA955 in cooling mode.</p>
<b>Dew point monitoring</b>	<p>A condensation monitor (QXA2000, AQX2000) monitors the dew point on the flow pipe.</p> <p>The condensation monitor acts simultaneously on both room groups (1 dew point monitor per QAX903).</p>
<b>Floor cooling enable</b>	<p>Floor cooling is enabled:</p> <ul style="list-style-type: none"> <li>– Manually on the QAX903.</li> <li>– Via external switch (digital).</li> <li>– Via programmable date.</li> <li>– Via composite outside air temperature.</li> <li>– Via KNX S-mode.</li> </ul>

## Specific functions for ventilation and air conditioning units

### Ventilation

The QAX903 can control a ventilation plant with up to 3 ventilation stages via multi-controller RRV934. The stages can be controlled manually, via a weekly scheduler or using an air quality or humidity sensor. Ventilation may be influenced by absences, holiday functions or an open window.

The following operating and control functions are available:

- The apartment timer activates apartment operating mode "Comfort" for an adjustable period.
- Rapid ventilation activates the maximum ventilation stage for a predefined period.
- Cooler outside air flows through the heat recovery bypass in summer mode as part of active night cooling.
- Count operating hours to generate a maintenance message.
- Enable kitchen fume hood via an open window to ensure replacement air.
- Display active chimney ventilation mode (external plant).

### Cooling enable contact

1 cooling enable contact can be assigned to each room to activate a cooling unit (e.g. split unit).

Enabling can occur via the local relay contact of the central apartment unit, the relay contacts on the heating circuit controllers RRV912 / RRV918, the multi-controller RRV934, RF adapter plug KRF960-x, or via S-mode.

### Air conditioning unit via ZENNiO module

Integration of the ZENNiO Interface (S-mode TP1) allows the central apartment unit to control the operating mode, setpoint and enabling for the air conditioning (e.g. split unit) per room. Heating and cooling mode for the air conditioning unit are supported.

Room temperature control is autonomously taken over by the air conditioning unit.

## Specific functions for window ventilation function

### Window contacts

The window contacts are used for the window ventilation function. As soon as a window monitored by a window contact is opened, the heating circuits for the respective room stop opening their valves, even if the room temperature drops for short periods. The room temperature level drops to protection mode after a set period expires, until the window is closed again. "Normal" control is resumed after the window is closed.

An open window can also influence operation of a ventilation plant or air conditioner.

This prevents unnecessary heat losses during the airing phase and subsequent overheating.

Exhaust hood operation can also be influenced by monitoring window contacts.

### Weather station

The central apartment unit receives measured values for outside air pressure and air pressure from the meteo sensor or via KNX-TP1.

The current measured values for outside air pressure and outside temperature as well as the air pressure trend can be displayed in the quiescent picture. The quiescent picture displays changes in outside air pressure over the last few hours in the form of an arrow.

Moreover, the weather trend (sunny, varying, bad) is determined based on a change in air pressure and absolute pressure, and is displayed in the quiescent picture.

The curve for outside air temperature and outside air pressure over the last 24 hours can be queried via 2 info pages.

## Specific functions to acquire and display consumption data

### Consumption data acquisition

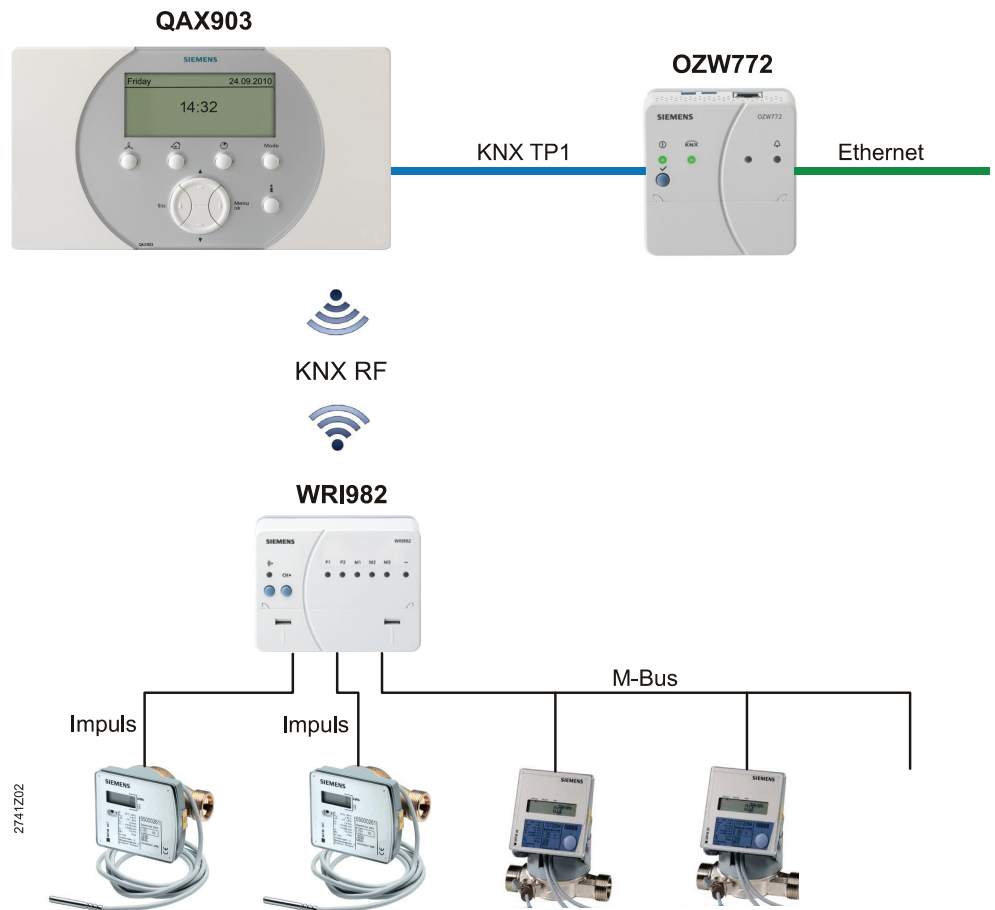

Integrating the consumption data interface WRI982 allows for displaying energy consumption on the central apartment unit and sending it to a service provider via web server OZW772.

Monthly and annual cutoff values are displayed and forwarded in addition to current meter readings. A corresponding info page is maintained for each meter type.

### Available meter types and max. number

2 pulse and 3 M-bus meters can be connected to one WRI982 (a total of up to 5 meters).

What types and number of meters can be integrated in a QAX903 central apartment unit?

- 4 heating and/or cooling meters
- 4 chilled water meters
- 4 hot water meters
- 3 electricity meters
- 3 gas meters
- 2 other meters (e.g. for steam or oil)

## Synergyr integration

The Synco living ECA system is fully compatible with the Synergyr system and allows for conversion of individual units in a Synergyr system (partial migration). The meter information is displayed on the QAX903 central apartment unit and forwarded via the Synergyr building bus to the OZW30 building central station.

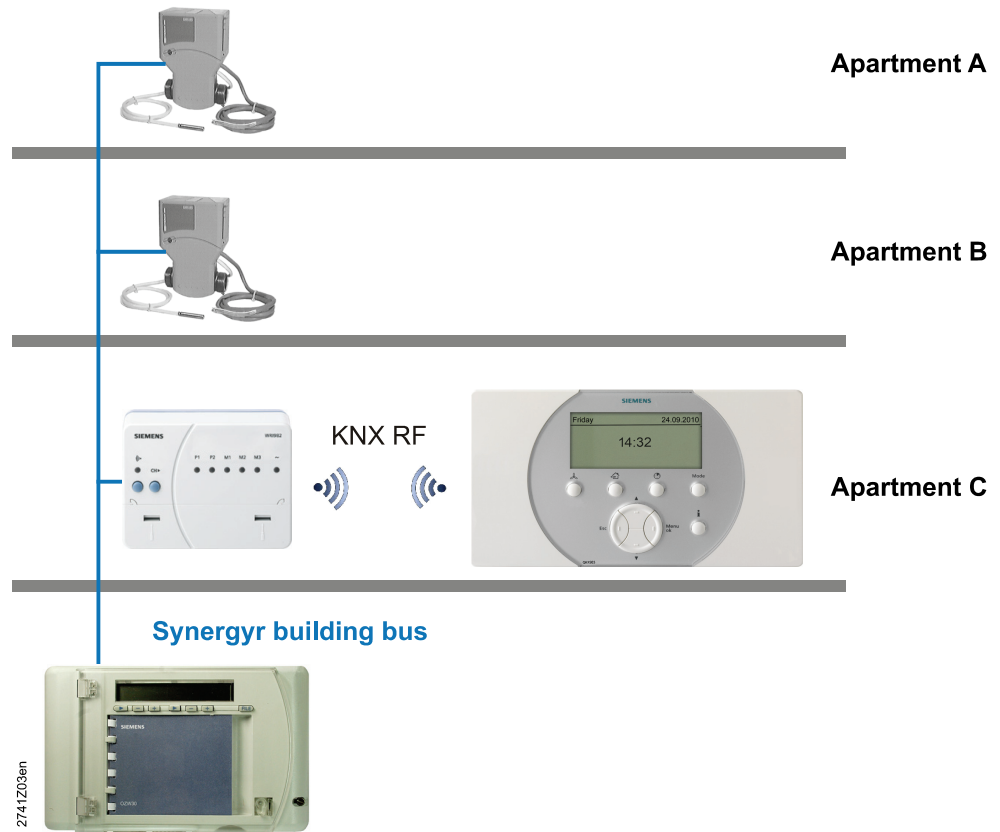

Detailed information the Synco living ECA system is available in the data sheet on the consumption data interface (N2735en).

## Device and system functions

### Inputs and outputs

Synco living features a number of inputs and outputs which can be used either via the universal input/output of the central apartment unit (locally), or the universal inputs/outputs of the RRV912 / RRV918 heating circuit controllers, or the RRV934 multi-controller.

The inputs and outputs can be assigned the following functions:

#### Inputs

- Changeover of apartment operating mode
- Changeover to summer operation
- Cooling enable
- Heating/cooling changeover
- Dew point monitor
- Flow and return sensor
- Ventilation contacts 1 and 2 (e.g. hygrostat)
- Chimney mode
- Triggering the absence function
- Air quality sensor (CO<sub>2</sub> sensor)
- Humidity sensors



## Outputs

- Transmit heat demand (switching)
- Transmit heat demand DC 0...10 V
- Transmit cooling demand (switching)
- Transmit cooling demand DC 0...10 V
- Cooling enable
- Switching room group pump 1 - 2
- Precontroller mixing valve 1 - 2
- Step switch 1 to 3 stages
- Heat recovery bypass
- Enable exhaust hood
- Enable cooling unit 1 - 12
- Transmit changeover to summer operation

<b>Communication</b>	The central apartment unit communicates via a wireless bus (KNX RF) or a wire-bound bus (KNX TP1).
<b>Service interface</b>	The OCI700 service tool can be connected to the service interface (RJ45) located on the underside of the central apartment unit.
<b>Establish wireless connection</b>	The individual wireless components are connected to the central apartment unit by selecting the room/function to be assigned to the new wireless component and then pressing the binding or function button on the corresponding component.
<b>Display wireless connections</b>	To check the connections, a list with all devices can be displayed for each room. In addition, the corresponding device indexes are available.
<b>RF link test</b>	Using the binding or multi-function buttons, a binding test can be triggered on the individual devices. The central apartment unit indicates error-free connections both optically and audibly.
<b>Monitor devices</b>	The connected RF devices are monitored on a regular basis. An error message is displayed on the central apartment unit when no transmit signal is found.
<b>RF failure</b>	<p>Control is no longer guaranteed if radio communications between the central apartment unit and the system components to be controlled are interrupted. If communication breaks down, the position of the actuators connected to an RRV912 / RRV918 heating circuit controller or multi-controller RRV934 is maintained and can only be changed manually. By using the built-in room temperature sensor, the SSA955 radiator control valves continue to control and maintain the room temperature set-point of 21 °C.</p> <p>The ventilation plant continues to operate on the present ventilation stage for about 30 minutes and is then shut down.</p> <p>The RF adapter plugs can be activated and deactivated directly via the function button on the adapter plug.</p> <p>System components resume normal control operation as soon as radio communications are reestablished.</p>
<b>Mains failure</b>	<p>Control is no longer guaranteed in the event of a power failure to the central apartment unit.</p> <p>If communication breaks down, the position of the actuators connected to an RRV912 / RRV918 heating circuit controller or multi-controller RRV934 is maintained and can only be changed manually.</p> <p>By using the built-in room temperature sensor, the SSA955 radiator control valves continue to control and maintain the room temperature setpoint of 21 °C.</p>

The ventilation plant continues to operate on the present ventilation stage for about 30 minutes and is then shut down. The air conditioner can be operated using the unit's own remote control.

The RF adapter plugs can be activated and deactivated directly via the function button on the adapter plug.

The central apartment unit and its components resume normal control operation as soon as power returns.

### Error messages

The QAX903 delivers detailed error messages to simplify localizing any errors. They are output as clear-text messages, thus simplifying interpretation of messages by the user or expert.

Error messages can be used for triggering other events, such as optical or audible alarms.

The last 10 error messages are saved in history and can be individually retrieved.

### Delivery state

The central apartment unit can be reset to the delivery state via an operating line.

### Application examples

1 room group with room control without precontrol

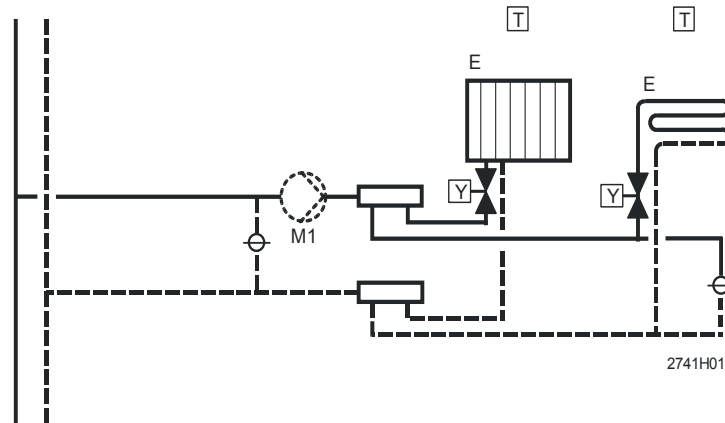

M1	Room group pump	Y	Heating circuit valve (2-point) or radiator – control actuator SSA955
E	Heating circuit		
T	Room unit and/or room temperature sensor		

2 room groups with one flow temperature control each

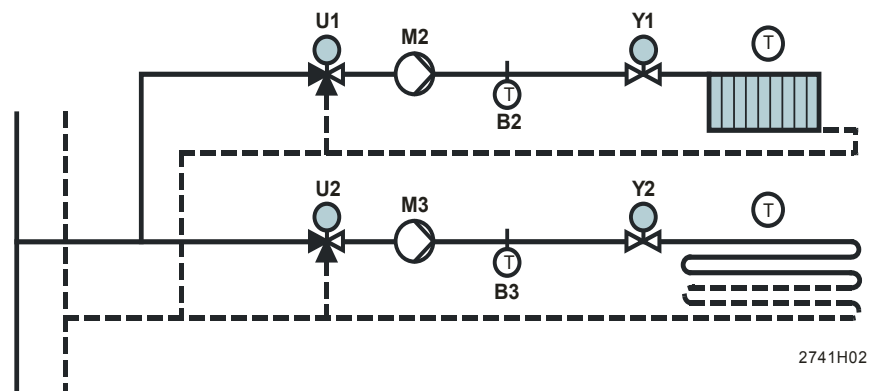

M2 - M3	Room group pump	Y1	Radiator – control actuator SSA955
T	Room unit and/or room temperature sensor	Y2	Heating circuit valve (2-point)
		B2 - B3	Flow sensor
		U1	Mixing valve radiator, DC 0...10 V
		U2	Mixing valve floor heating, DC 0...10 V

Ventilation plant  
integration

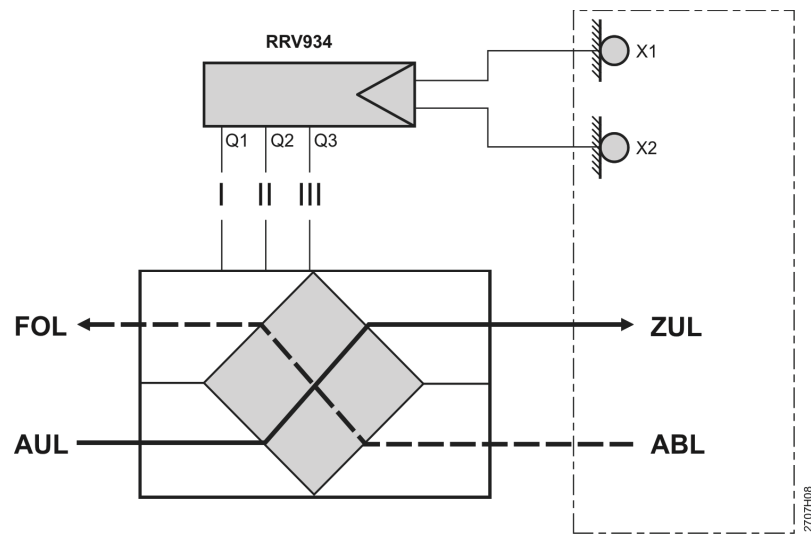

Q1 - Q3 3-stage step selector of ventilation plant  
 X1 Air quality sensor, DC 0...10 V  
 X2 Humidity sensor DC 0...10 V

FOL Exhaust air  
 AUL Outside air  
 ZUL Supply air  
 ABL Extract air



2741P01.tif

### Operating element functions



#### **Ventilation button**

Button for ventilation mode.

To set the ventilation state (Auto / Off / Stage 1 / Stage 2 / Stage 3) for one-time rapid ventilation.



#### **Absence button**

To select the absence function (absent/present). The Absence function influences heating, cooling, and ventilation.



#### **Apartment timer button**

To set and activate the timer function for selected rooms. Rooms are heated or cooled to the selected setpoint (Comfort, Precomfort or Economy) and runs ventilation on the corresponding setpoint stage while the timer function is enabled.



#### **Mode button**

To select the operating mode for the apartment (Auto / Comfort / Precomfort / Economy / Protection). The apartment operating mode simultaneously acts on room control and ventilation.



#### **Info button**

To scroll through the info pages and to display Help texts on the menu level.



#### **Up arrow**

To navigate up on a menu level, to scroll backward on the info pages, and to set (increase) values.



#### **Down arrow**

To navigate downward on the menu level, to scroll forward on the info pages, and to set (decrease) values.



#### **Esc button**

To navigate back to the next higher menu level, to quit the main menu, or to abort entry of values.



#### **Menu / ok button**

To open the main menu, to navigate to a lower menu level, or to confirm entry of values.

## Display

- Fully graphic backlit display
- Visualization of information with symbols and clear-text output
- Info pages for:
  - Outside air temperature curve
  - Air pressure curve
  - Window
  - Apartment
  - Ventilation
  - Room
  - Consumption data
  - Business card
  - Device status
  - Fault status message bus
- Selectable format of quiescent picture

## Notes on engineering and operation

---

### Mounting location

- Comply with all local regulations on electrical systems.
- The central apartment unit is designed for surface mounting.
- Mount the QAX903 in a space that is easily accessible (e.g. in the living room or in the hall). Choose the mounting height above the floor so that the unit is easily accessible. The QAX903 does not contain its own temperature sensor. The mounting height has no impact on control performance.
- Observe all permissible ambient conditions.
- Do not expose the QAX903 to dripping water.

### Note

For notes relating to engineering and mounting wireless devices for the Siemens Synco living system, see data sheet N2708en.

### Mounting

Use at least three screws to mount the QAX903 to an apartment's interior wall.

### Maintenance

The QAX903 is maintenance-free.

### Disposal



For disposal, the central apartment unit and the various partner devices are classified as electronic scrap under the European Directive 2002/96/EC (WEEE) and may not be disposed of as domestic waste. Follow all relevant national regulations and use only appropriate channels to dispose of the units. Follow all local laws and regulations. Dispose of used batteries pursuant to all environmental regulations.

## System limits

---

**System limits (bus TP1)** 126 Central apartment units QAX903

**Limitation per central apartment units**

1	Meteo sensor
12	Rooms
1	Humidity sensor
1	Air quality sensor
1	Condensation monitor
3	RF repeaters
4	Heat meters (heating, cooling or combined)
4	Hot water meters
4	Chilled water meters
3	Electricity meters
3	Gas meters
2	Other meters (e.g. oil, steam)
94	RF components (total, including central apartment unit)

**Limitations per room**

1	Room unit
2	Room temperature sensors
1	Heating circuit controller with a maximum of six channels*
6	Radiator control actuators (1 lead controller, 0 - 5 lag controllers) or heating circuit controller channels
6	Window contacts

Note \* Radiator control actuators and heating circuit controllers cannot be used simultaneously in the same room.

## Warranty

---

Application-related technical data are only warranted in connection with the Siemens Synco living system.

**User is responsible for proper operation of QAX903 when used together with third-party devices not specifically mentioned here. Siemens assumes no responsibility for service and warranty under these circumstances.**

## Technical data

---

Power	Operating voltage	AC 230 V ( $\pm 10\%$ )
	Rated voltage	AC 230 V
	Frequency	50 Hz
	Power consumption (with no external load)	Max. 7 VA
	External supply line fusing	<ul style="list-style-type: none"><li>• Non-renewable fuse, slow to a max. 10 A</li><li>• Automatic line cutout max. 13 A</li></ul> Release characteristic: B, C, D, as per EN 60898
	Clock reserve	Typically 72 hours
Radio communication	RF	868.3 MHz (bidirectional)
	Range	Typically 30 m in buildings
	RF protocol	KNX RF-compatible 

Wired communications	Bus protocol / type	KNX TP1 		
	Bus power supply	Simplified bus power supply, 12.5 mA; bus power supply may only be switched on for operating an OZW771 or OZW772.		
	Service interface	RJ45 plug on underside of housing		
Display	Fully graphic backlit display (white background)			
Universal input	Type	LG-Ni 1000 resistance, on/off		
	Number	1		
	Measuring range	0...120 °C		
Permissible cable length to sensor or external switch	Copper cable 0.6 mm dia.	Max. 20 m		
	Copper cable 1 mm <sup>2</sup>	Max. 80 m		
	Copper cable 1.5 mm <sup>2</sup>	Max. 120 m		
Relay output	Type	NO contact AC 24...230 V, AC 0.02...2 (2) A		
	Number	1		
Electrical connection	Screw terminals for wire cross section	Max. 1.5 mm <sup>2</sup>		
Standards and directives	 -Conformity as per			
	EMC directive	2004/108/EC		
	- Immunity, emissions	- EN 60730-1, EN 50491-5-2		
	Low-voltage directive	2006/95/EC		
	- Electrical safety	- EN 60730-1, EN 50491-3		
RTTE Radio & Telecom. equipment)	1999/5/EC			
	- Radio communication	- EN 300220-2, EN 301489-1, EN 301489-3		
Environmental compatibility	Environmental Declaration CE1E2740en	ISO 14001 (environment)		
	contains data on environmentally compatible product design and assessment	ISO 9001 (quality)		
	(RoHS compliance, compositions, packaging, environmental benefits and disposal)	SN 36350 (environmentally compat. products)		
		RL 2002/95/EC (RoHS)		
Protection	Protection class	II as per EN 60730		
	Degree of protection of housing	IP20D as per EN 60529		
	Degree of pollution	2 as per EN 60730		
Dimensions	See "Dimensions"			
Weight	Unit complete with accessories			
	- QAX903-xx	0.854 kg		
	- QAX903-9	0.581 kg		
Housing material	Plastic ASA+PC			
Housing color	White NCS S 0502-G			
Ambient conditions		<b>Operation</b>	<b>Transport</b>	<b>Storage</b>
		60721-3-3	60721-3-2	60721-3-1
	Climatic conditions	Class 3K5	Class 2K3	Class 1K3
	Temperature	0...+45 °C	-25...+70 °C	-20...+65 °C
	Humidity	< 95 % r.h. (non-condensing)	<95 % r.h.	< 95 % r.h. (non-condensing)
	Mechanical conditions	Class 3M2	Class 2M2	Class 1M2
	Elevation above sea level	Min. 700 hPa, Max. 3,000 m above sea level		

## Connection terminals

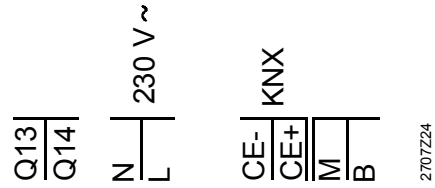

- Q13, Q14 Universal, potential-free relay output  
 N Operating voltage, neutral conductor AC 230 V  
 L Operating voltage, phase AC 230 V  
 CE-, CE+ Connection of data bus KNX TP1- and KNX TP1+  
 M Ground for universal input  
 B Universal input

## Connection diagram

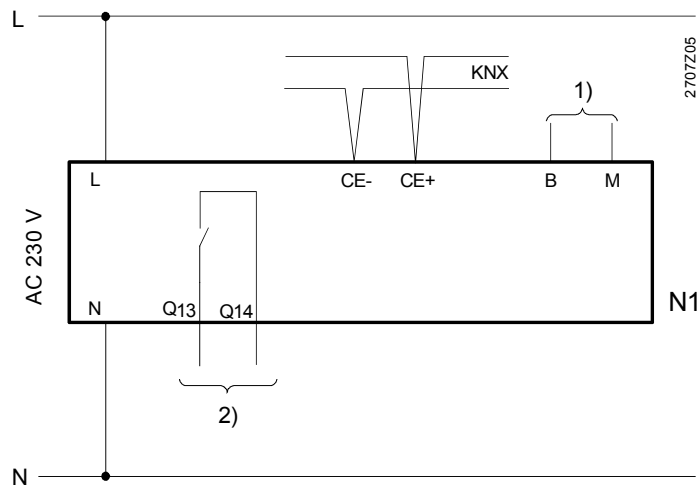

- N1 Central apartment unit QAX903  
 1) Universal input, for temperature measurement/digital input  
 2) Universal, potential-free relay output, for mains or low voltage  
 L Phase AC 230 V  
 N Neutral conductor AC 230 V  
 CE- / CE+ Connection of wire-bound bus (KNX TP1- and KNX TP1+)



# Dimensions

Dimensions in mm

## Central apartment unit

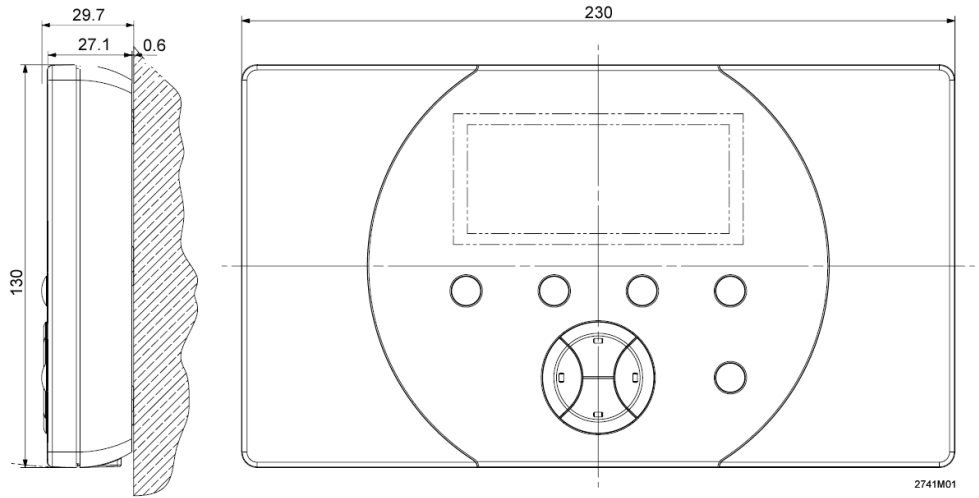

## Base

